

# INSTALLATION MANUAL

# RIVAL

4x4 ACCESSORIES

PRODUCT: FRONT ALUMINUM BUMPER

APPLICATION: FORD RANGER (2022 - PRESENT)

PART NO: 2D.1819.1-NL



## CAUTION!

To reduce the risk of serious injury or damage to property: Before you start installing and using this product, read the full instructions, pay special attention to the conditions of safe use and recommendations for installation! When installing or maintaining this product, it is necessary to use protective goggles. Check the integrity of the structure and the moment the fastening is tightened every 250 miles (400 kms) of mileage. Do not use this product if there is damage to the structure or fasteners!

## NOTICE

Skid plate is an additional protection, but it can not guarantee to protect against all possible damage in collisions. When driving, be careful of objects and terrain that may damage sensitive parts of the vehicle.

# FRONT BUMPER

# RIVAL

4x4 ACCESSORIES

Part number: 2D.1819.1-NL

Suited to vehicle: Ford Ranger (2022-Present)

Material: Aluminum / steel



## SAFETY NOTICE

- \* The RIVAL Bumper is designed to compliment the use and design of the specified vehicle under conditions specified by the vehicle manufacturer.
- \* While driving the vehicle at any speed, collision with any other vehicle, animal or object must always be avoided.
- \* Following any collision with any other vehicle, animal or object, the RIVAL Bumper and the vehicle must be inspected by a specialized or suitably qualified vehicle repairer for possible damage to the components and assemblies in order to confirm suitability for further use of the vehicle.
- \* It is strongly recommended that you do not operate a vehicle with a damaged bumper or its components. In the case of damage, please contact the nearest RIVAL dealer. Vehicle, or where the bumper has been damaged, is extremely dangerous and must be avoided at all cost.
- \* The operation of a vehicle where the bumper is not properly attached and fastened to the vehicle, or where the bumper has been damaged, is extremely dangerous and must be avoided at all cost.
- \* It is recommended that you carry out regular inspections of all the bumper elements such as all bolts, wires, connectors.
- \* A winch with a pull capacity of up to and including 12000 lb can be installed with the RIVAL Bumper. It is not advisable to exceed this pulling capacity since damage, injury or death may occur where the 12000lb recommended capacity is exceeded. The Rival bumper provides standard 4 1/2"x10" mounting holes.

## INSTALLATION NOTICE

- \* Personal safety during the installation process must be adhered to at all times.
- \* Estimated time for installation: 4 hours.
- \* The RIVAL Bumper must be mounted and affixed to the vehicle according to this installation manual and the use of personal safety equipment is highly recommended.
- \* Do not install this bumper on vehicle models other than those allowed in this manual.
- \* Check state and local highway safety laws regarding permitted bumper types and heights.

**NOTE:** if the bumper is to be color coded it is advised to test fit before color coding. RIVAL is not liable for color coding cost, it is the installers' responsibility to check the fitment and alignment before color coding.

### ADR69 AND AIR BAG SYSTEM

The Rival bumper has been tested and certified to be compatible with ADR69 and will not affect the operation of the Air bag System on this vehicle. This product or mounting brackets must not be modified in any way, and must be fitted in accordance with the installation instructions.

## REQUIRED TOOLS

- \* Basic tool kit
- \* Torque wrench
- \* Crosspoint and flat head screwdriver
- \* Marker
- \* Angle grinder
- \* Drill

## TORQUE SETTING

- \* M6 - 9 N·m
- \* M8 - 24 N·m
- \* M10 - 44 N·m
- \* M12 - 77 N·m

## WINCH INSTALLATION

A winch with a pull capacity of up to 12000 lbs can be installed with the RIVAL Bumper. It is not advisable to exceed this pulling capacity since damage, injury or death may occur where the 12000 lbs recommended capacity is exceeded.

Winch measurements:

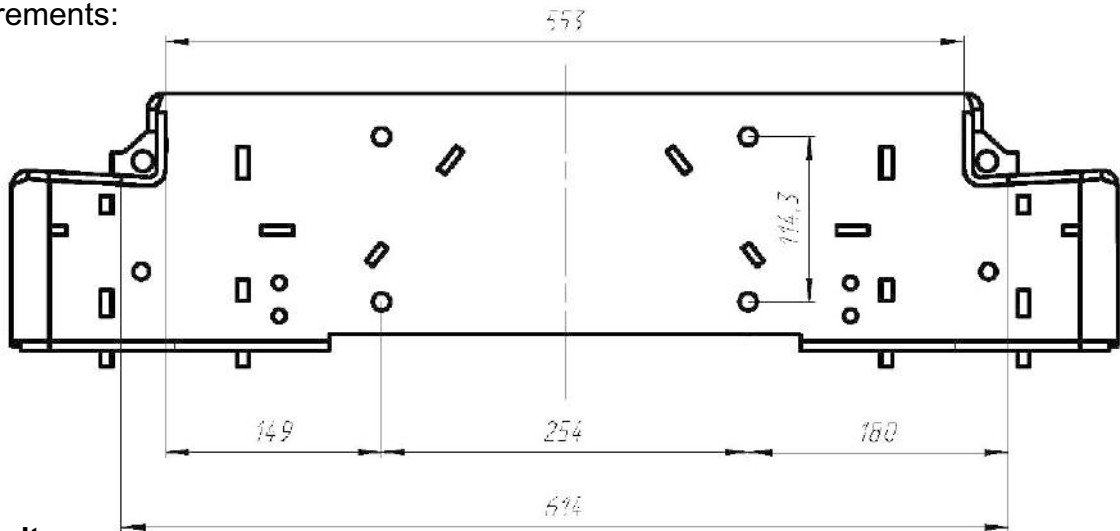

**Winch size limits:**

L 614 x W 170 mm x H 226 mm

## LIGHTBAR

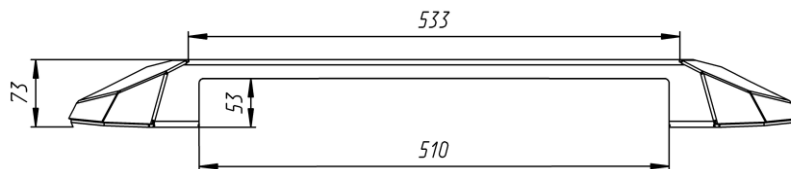

**Lightbar size limits:**

L 535 x W 93 mm x H 71 mm

## LIGHTS

The bumper provides for the light mounting points.

**Overall dimensions of the lights under installation:**

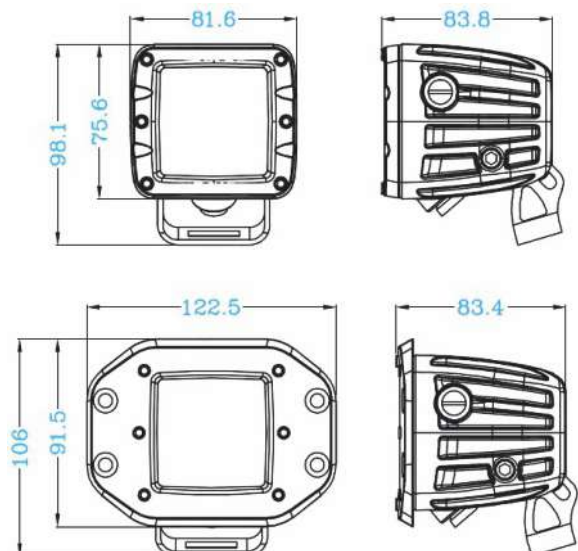

## RECOVERY POINTS



### **WARNING!**

Do not exceed the Working Load Limit of these recovery points or shackle.

### **INSPECTION AND SAFETY**

Recovery of stuck vehicles can be dangerous. Always inspect the shackle and recovery points before each use. Do not use if there are visible signs of damage or wear including cracking (or elongation). Always stay a safe distance away from the recovery area - at least 1.5 times the length of the recovery strap. Incorrect use of receivers equipment can result in serious injury or death.

Always use recovery points as a matched pair teamed with an equalising bridle during any recovery situation.

Please attach this "Warning" label to the door aperture.

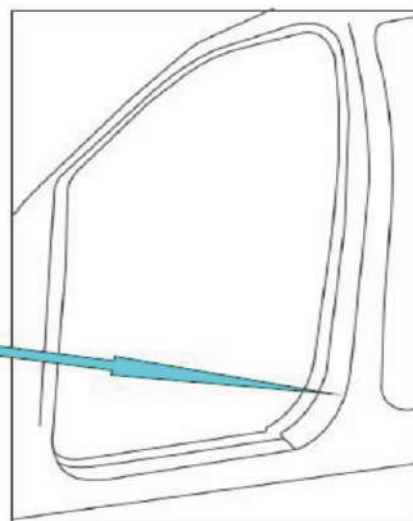

# PARTS LISTING

# RIVAL

4x4 ACCESSORIES

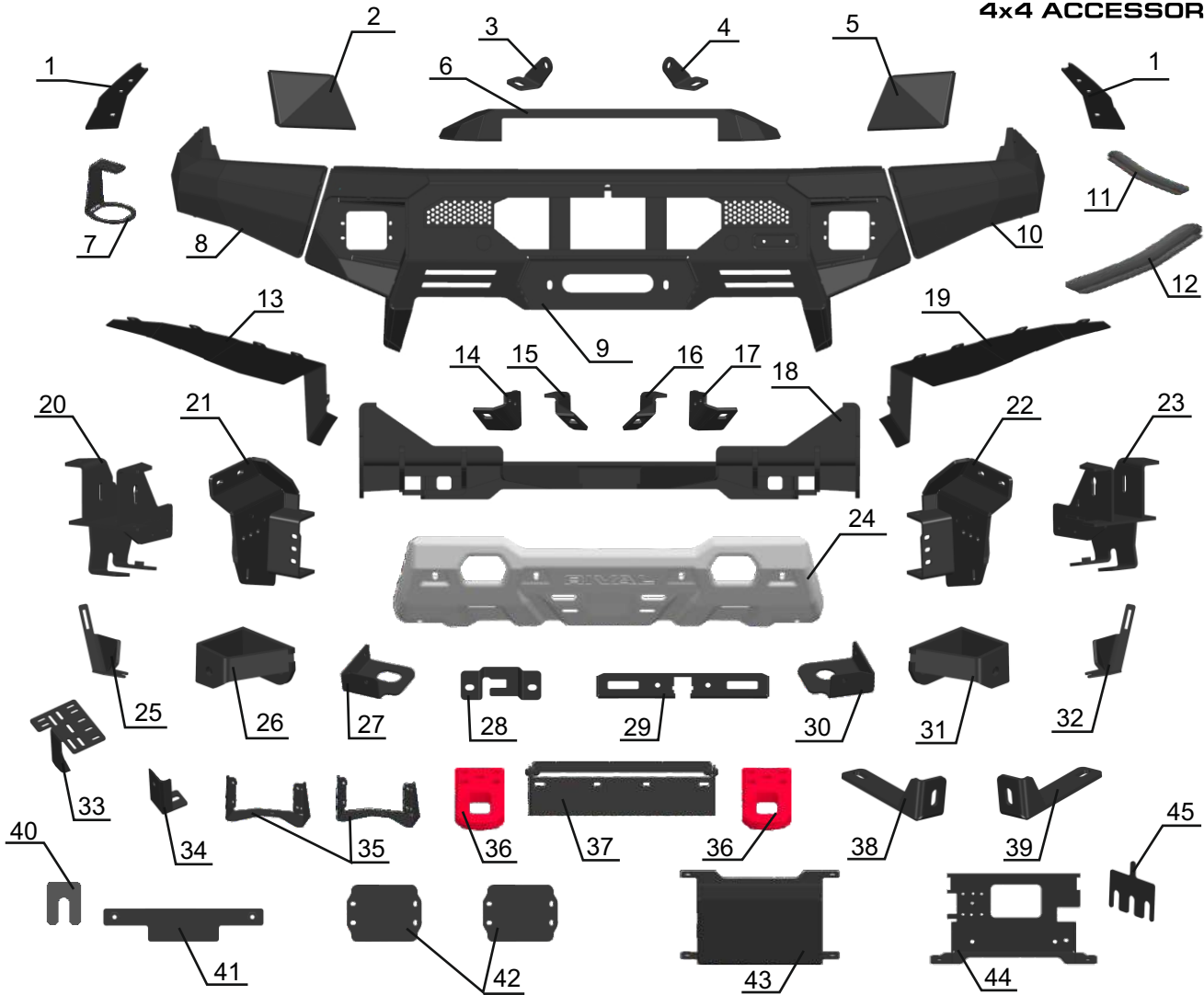

1. End cap cover.....	Qty 2	24. Bash plate.....	Qty 1
2. Right plug between wing and light.....	Qty 1	25. Right grille bracket.....	Qty 1
3. Right lightbar bracket.....	Qty 1	26. Right adjustment bracket.....	Qty 1
4. Left lightbar bracket.....	Qty 1	27. Right intercooler bracket.....	Qty 1
5. Left plug between wing and light.....	Qty 1	28. Camera clamp.....	Qty 1
6. Lightbar cap.....	Qty 1	29. Camera bracket.....	Qty 1
7. Wrench for mounting parking sensors.....	Qty 1	30. Left intercooler bracket.....	Qty 1
8. Right end cap.....	Qty 1	31. Left adjustment bracket.....	Qty 1
9. Bumper body.....	Qty 1	32. Left grille bracket.....	Qty 1
10. Left end cap.....	Qty 1	33. Winch control box bracket (part 1).....	Qty 1
11. Weatherstrip (L=250mm).....	Qty 2	34. Winch control box bracket (part 2).....	Qty 1
12. Weatherstrip (L=500mm).....	Qty 2	35. LED bracket.....	Qty 2
13. Right flap.....	Qty 1	36. Recovery point.....	Qty 2
14. Right bash plate bracket 1.....	Qty 1	37. License plate bracket.....	Qty 1
15. Right bash plate bracket 2.....	Qty 1	38. Right fairlead bracket.....	Qty 1
16. Left bash plate bracket 2.....	Qty 1	39. Left fairlead bracket.....	Qty 1
17. Left bash plate bracket 1.....	Qty 1	40. Adjusting plate 2mm.....	Qty 6
18. Winch bracket.....	Qty 1	41. License plate insert nut.....	Qty 1
19. Left flap.....	Qty 1	42. LED light cap.....	Qty 2
20. Right reinforcing bracket.....	Qty 1	43. Radar cap.....	Qty 1
21. Right frame bracket.....	Qty 1	44. Radar bracket.....	Qty 1
22. Left frame bracket.....	Qty 1	45. Adjusting plate.....	Qty 4
23. Left reinforcing bracket.....	Qty 1		

# PARTS LISTING

# RIVAL

4x4 ACCESSORIES

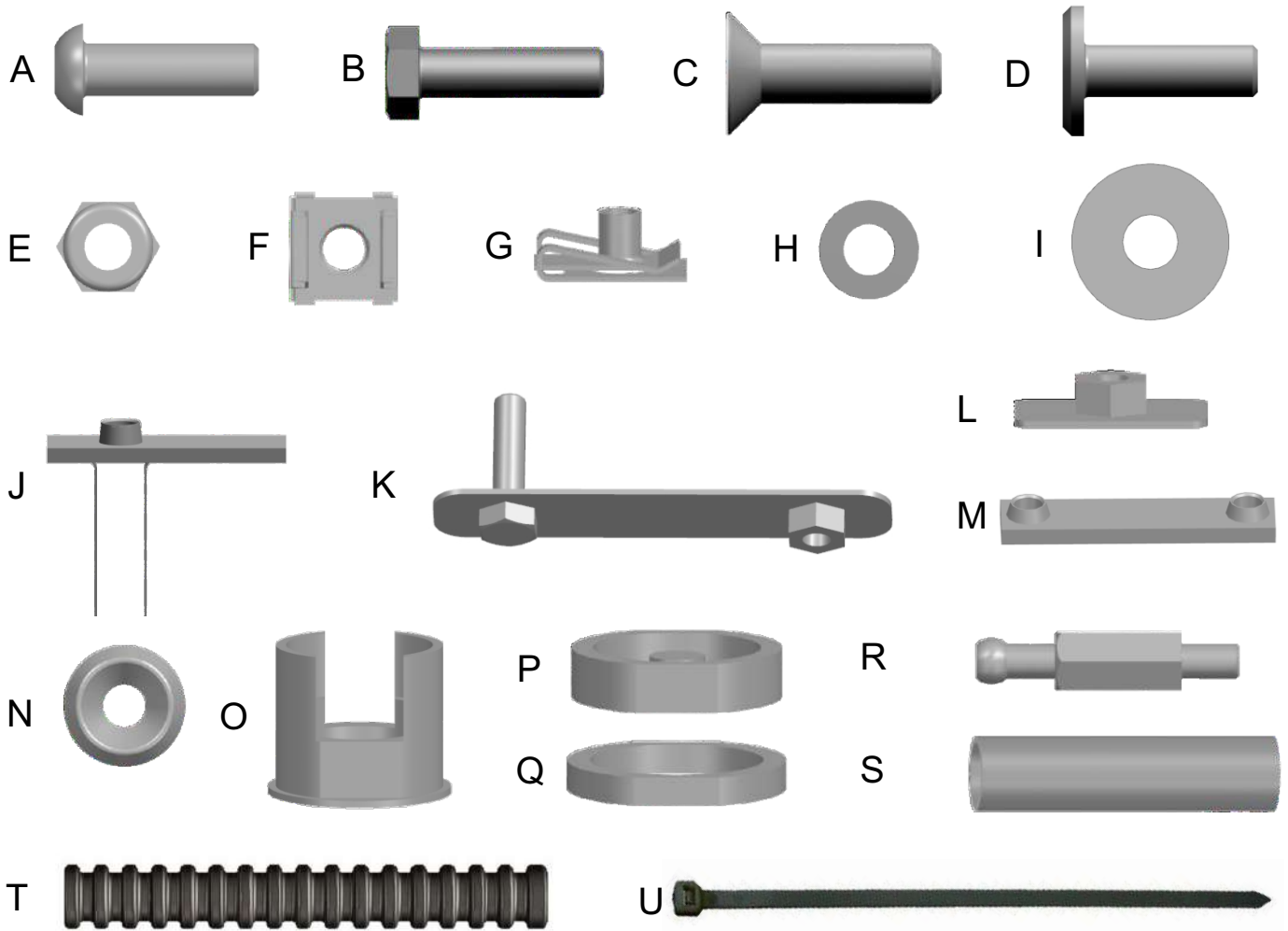

A1. Screw M6x1x16.....	Qty 8	H2. Washer M8.....	Qty 25
A2. Screw M6x1x20.....	Qty 48	H3. Washer M10.....	Qty 34
B1. Bolt M8x1.25x30.....	Qty 17	H4. Washer M12.....	Qty 32
B2. Bolt M10x1.5x30.....	Qty 17	I1. Penny washer M6.....	Qty 22
B3. Bolt M10x1.5x40.....	Qty 2	I2. Penny washer M8.....	Qty 8
B4. Bolt M12x1.75x40.....	Qty 6	I3. Penny washer M10.....	Qty 6
B5. Bolt M12x1.75x60.....	Qty 8	J. Insert nut M10x65x20 with wires.....	Qty 6
B6. Bolt M12x1.75x110.....	Qty 2	K. Insert nut M10x1.5.....	Qty 2
C. Screw M10x1.5x40.....	Qty 10	L. Insert nut M10x43x30.....	Qty 2
D. Screw M6x1x20.....	Qty 6	M. Insert nut 2M6x1.....	Qty 2
E1. Nut M3x0.5.....	Qty 4	N. Countersunk washer M10.....	Qty 10
E2. Nut M6x1.....	Qty 25	O. Parking sensor holder.....	Qty 8
E3. Nut M8x1.25.....	Qty 20	P. Clamp of parking sensor.....	Qty 8
E4. Nut M10x1.5.....	Qty 21	Q. Nut of parking sensor.....	Qty 8
E5. Nut M12x1.75.....	Qty 16	R. Radar mounting pin.....	Qty 2
F. Cage nut M8x1.25.....	Qty 4	S. Spacer.....	Qty 2
G. Cage nut M6x1.....	Qty 20	T. Corrugated pipe.....	Qty 1
H1. Washer M6.....	Qty 58	U. Cable tie.....	Qty 16

## Preparation for installation



Fig.1

1. Open the hood. Disconnect terminal “-” from the vehicle battery (fig.1).

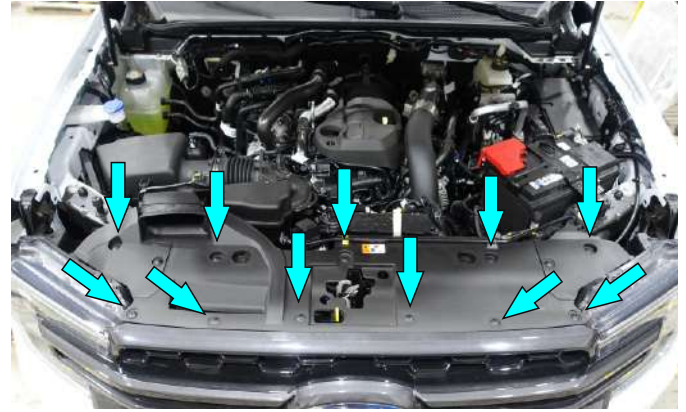

Fig.2

2. Release the phillips head clips to remove the top cover (fig. 2).

**\*Set aside for re-use later on.**



Fig.3

3. Unscrew factory bolts (fig.3).

**\*Set aside for re-use later on.**



Fig.4

4. Disconnect factory wiring (fig.4).



Fig.5

5. Remove radiator grille (fig.5).

**\*Set aside for re-use later on.**

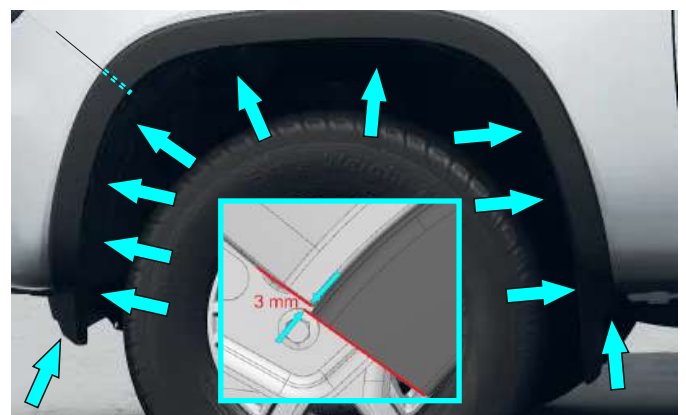

Fig.6

6. Mark a cutting line as shown in fig 6. Remove plastic clips and factory bolts to take off factory fenders.

# INSTALLATION PROCEDURE

# RIVAL

4x4 ACCESSORIES



Fig.7

7. Before cutting, make sure that marked cutting line is perpendicular to edge of fender. After that cut plastic fenders using a jig-saw. (fig.7).



Fig.8

8. Install factory plastic fenders and secure them using factory hardware (fig.8).



Fig.9

9. Remove factory clips push aside front factory fender liner (fig.9).

**\*Set aside for re-use later on.**



Fig.10

10. Unscrew factory bolts (fig.10).



Fig.11

11. Unscrew bolts, remove factory skid plate or any aftermarket skid plate (fig.11).



Fig.12

12. Unscrew factory bolts on both sides of the vehicle (fig.12).



Fig.13

13. Remove plastic clips, unscrew bolts and remove factory bumper (fig.13).



Fig.14

14. Remove plastic clips and polyfoam damper (fig. 14).

**If your vehicle is not fitted with radar, skip steps 15-16**



Fig.15

15. Unscrew factory bolts (fig.15,16).



Fig.16



Fig.17

16. Remove the radar cover, unplug an electronic connector (fig.17).  
**\*Set aside for re-use later on.**



Fig.18

17. Remove factory bolts and clips. Next, remove factory plastic covers (fig.18).

# INSTALLATION PROCEDURE

# RIVAL

4x4 ACCESSORIES

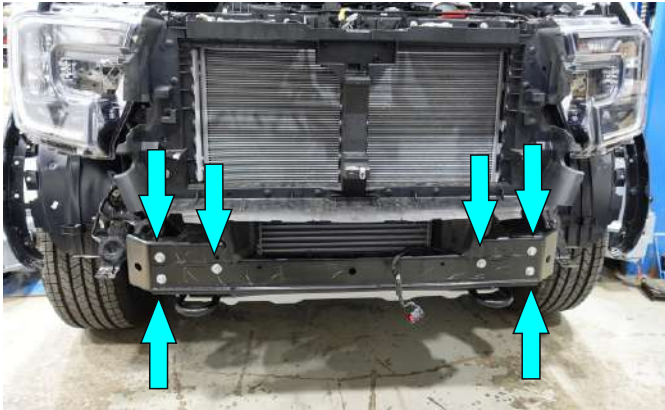

Fig.19

18. Unscrew bolts and remove factory crossmember (fig. 19).

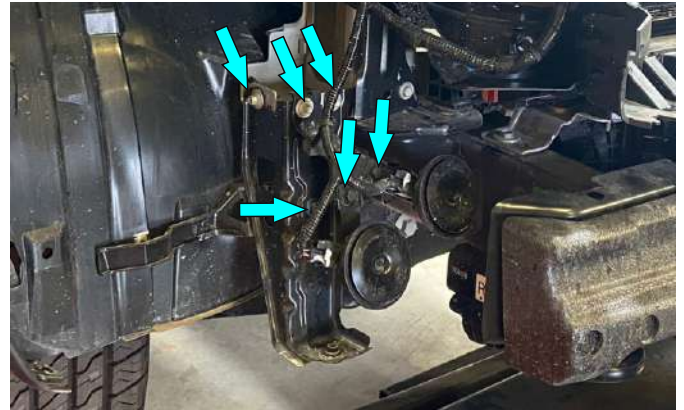

Fig.20

19. Unscrew bolts and remove factory brackets on both sides of the vehicle (fig.20).  
**\*Set aside for re-use later on.**



Fig.21

20. Install factory horn as shown in fig.21 and secure it using factory bolts.

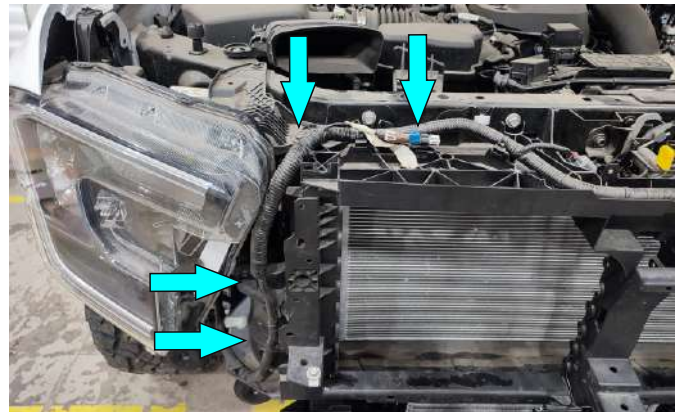

Fig.22

21. Cut the cable ties that secure the wiring (fig. 22).  
**\*If your vehicle is not fitted with front camera, skip steps 21-23.**



Fig.23

22. Remove corrugated pipe and pull out camera wiring and camera pipe.

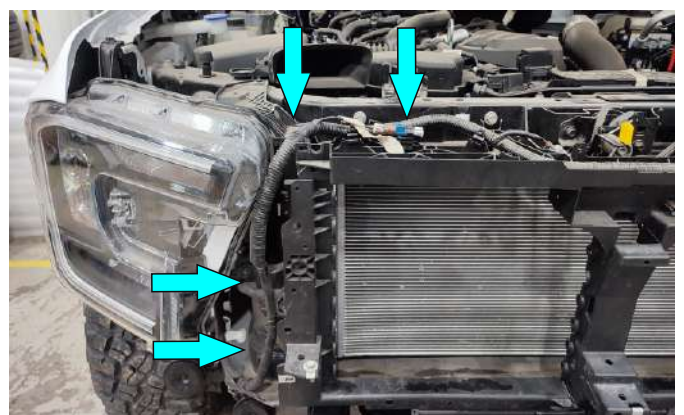

Fig.24

23. Return corrugated pipe, secure wiring using cable ties (item V). Insert corrugated pipe (item U) on camera wiring, insulate the wiring harness.

# INSTALLATION PROCEDURE

# RIVAL

4x4 ACCESSORIES

If your vehicle is not fitted with radar, skip steps 24-25

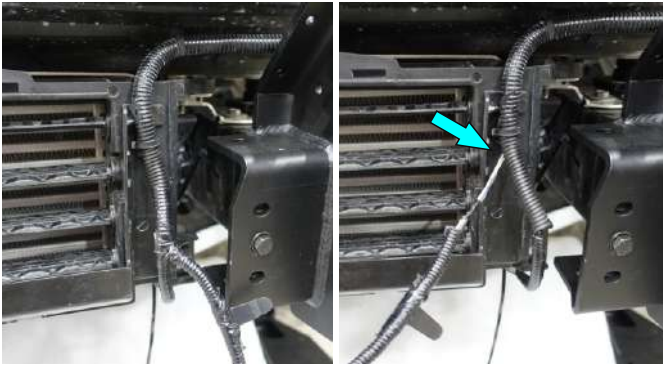

Fig.25

24. Remove insulation from the wiring. Pull the radar wiring out.



Fig.26

25. Insulate the wiring. Insert corrugated pipe (item U) on radar wiring and insulate it.

## Winch bracket installation procedure

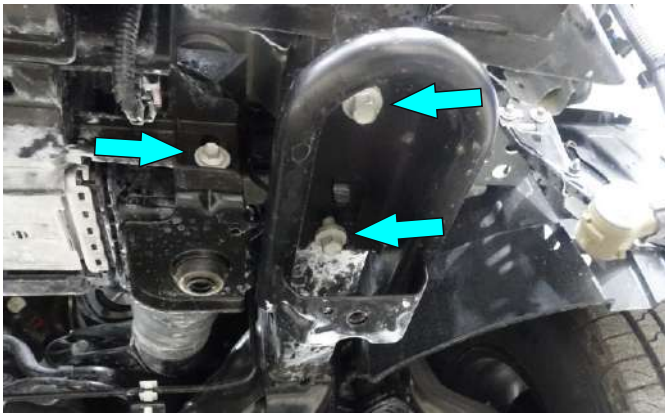

Fig.27

26. Remove factory recovery point from left side of vehicle (fig.27).

**\*Set aside for re-use later on.**

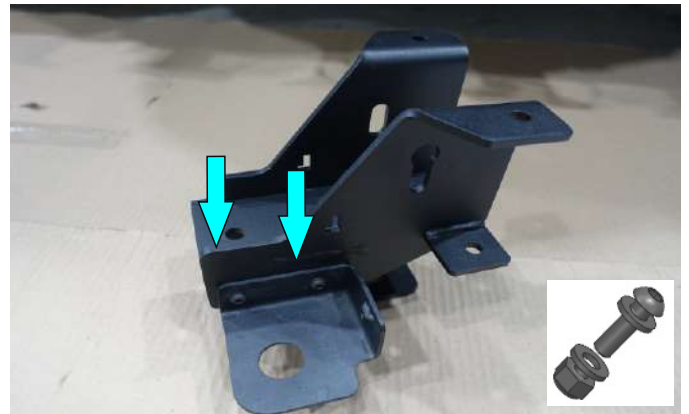

Fig.28

27. Secure left intercooler bracket to left reinforcing bracket (items 27, 30) using screws M6x20, washers M6, nuts M6 (items A2, H1, E2).

**\*Tighten hardware after that.**

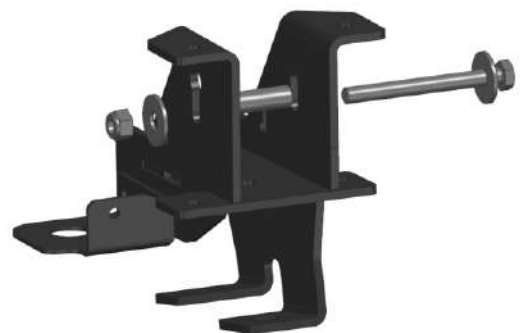

Fig.29

28. Secure reinforcing bracket (item 23) on the left side of the frame using bolt M12x110, washers M12, spacer and nut M12 (items B7, H4, S, E5) (fig.29).

**\*Spacer should be installed from inner side of the frame.**

**\*Do not tighten yet.**



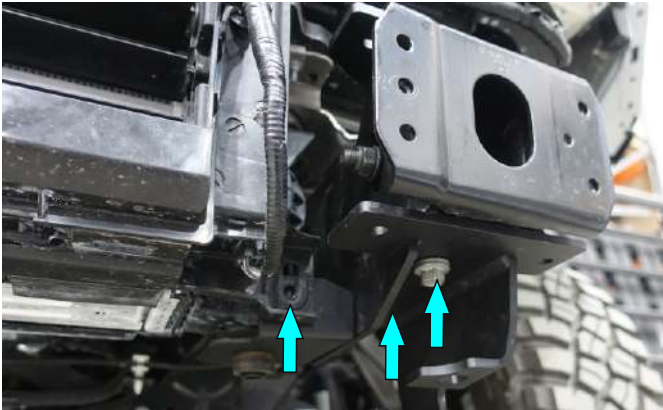

Fig.30

29. Secure left reinforcing bracket (item 23) using factory bolts (fig.30).

**\*Do not tighten yet.**

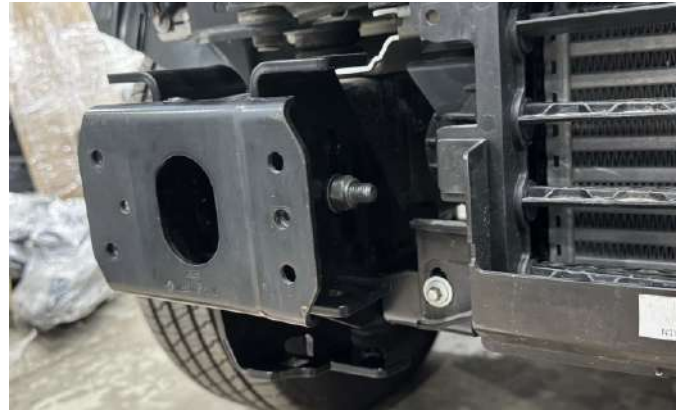

Fig.31

30. Repeat steps 26-29 for right side of vehicle.

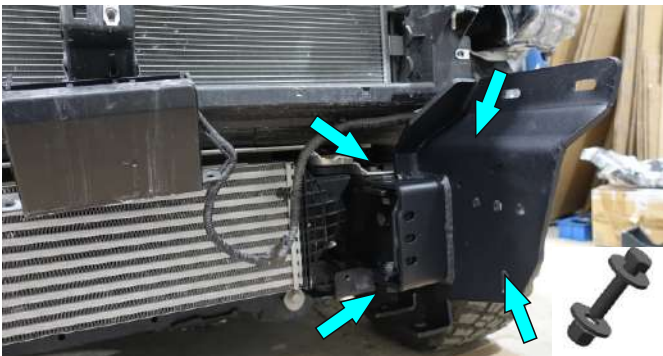

Fig.32

31. Secure frame brackets (items 21, 22) using bolts M10x30, washers M10, nuts M10 (items B2, H3, E4).

**\*Do not tighten yet.**

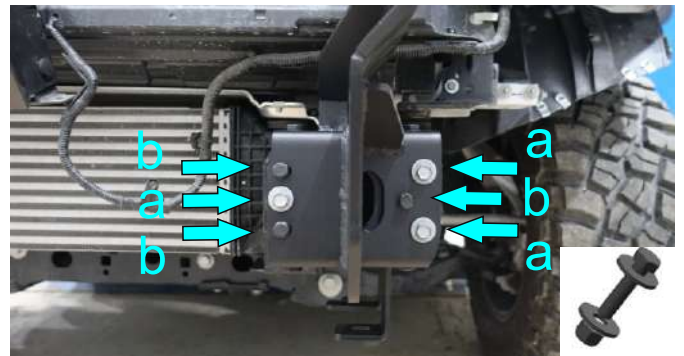

Fig.33

32. Secure frame brackets using:  
a - factory bolts (from step 18);  
b - bolts M8x30, washers M8, nuts M8 (items B1, H2, E3).

**\*Do not tighten yet.**

Repeat steps 31-32 for right side of vehicle.



Fig.34

33. Measure the internal distance between the front mounting points of bumper body (item 9) (fig. 34). Set up the brackets according to (measured distance + 2 mm) (fig.34).

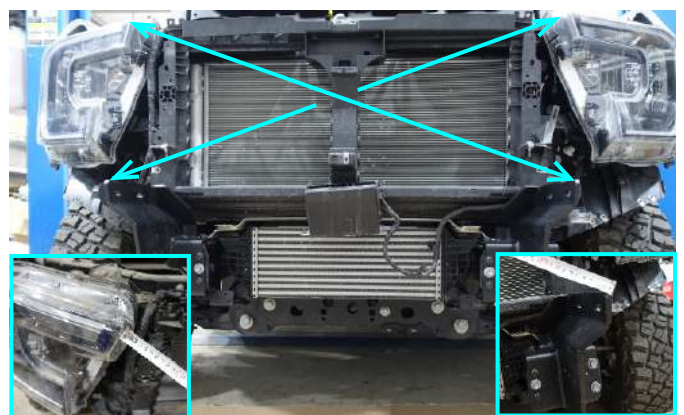

Fig.35

34. Make sure that the distance from the headlights to the opposite corners of frame brackets are the same (fig.35).

**\*Tighten hardware after that.**

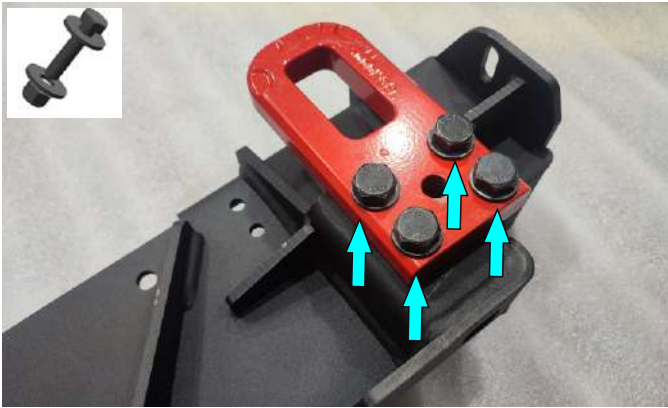

Fig.36

35. Install recovery points (item 36) to the winch bracket using bolts M12x60, washers M12, nuts M12 (items B5, H4, E5).

**\*Tighten hardware after that.**



Fig.37

36. Secure winch bracket (item 18) using bolts M12x40, washers M12, nuts M12 (items B5, H4, E5) as shown in fig. 37. If necessary, use adjustment plates (item 42) to eliminate the gap between the winch bracket and the frame brackets. If the gaps are very small, it is allowed to install the plate only on the one side.

**\*Do not tighten yet.**



Fig.38

37. Insert bolts M10x40 (item B4) into the grooves to ensure the holes in the brackets (items 18, 21, 22) are aligned.

**\*Tighten hardware from step 36.**

**\*\*Remove the M10x40 bolts (item B4) from the grooves.**

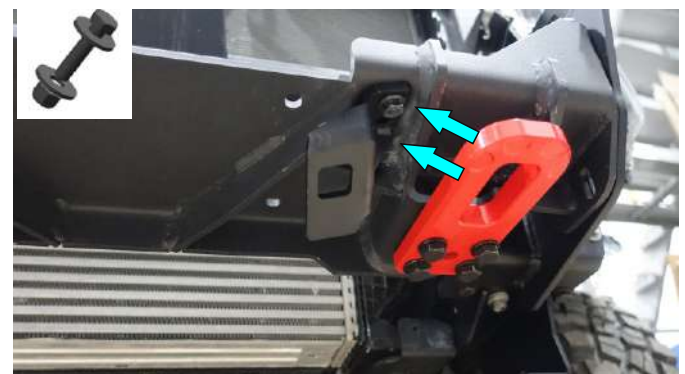

Fig.39

38. Install left and right bash plate bracket 2 (item 15,16) to the winch bracket using bolts M8x30, washers M8, nuts M8 (items B1, H2, E3).

**\*Tighten hardware after that.**

## Winch installation procedure (steps 39-43)

**\* If you are planning to install winch later, save winch control box and fairlead brackets (items 33, 34, 38, 39).**

**\* If your winch has a control box mounted on top, remove it before installation.**

# INSTALLATION PROCEDURE

# RIVAL

4x4 ACCESSORIES



Fig.40

39. Put the winch on pre-installed winch bracket. Insert fairlead brackets (items 38, 39) between the winch and the winch bracket. Next, adjust the fairlead brackets and the winch so that the holes are matched. After that, secure the winch using bolts and nuts that are included with the winch.

**\*Do not tighten yet.**

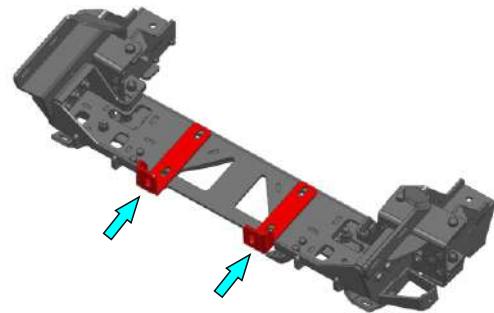

Fig.41

40. Connect the parts (items 33, 34) of the winch bracket using bolt M8x30 and washer 8 (item B1, H2).

**\*Do not tighten yet.**



Fig.42

41. Install winch control box to bracket (item 33) using bolts that are included with the winch.

**\*Do not tighten yet.**



Fig.43

42. Secure winch control box bracket to winch bracket using bolt M10x30, washer M10, nut M10 (items B2, H3, E4).

**\*Do not tighten yet.**



Fig.44

43. By moving and rotating the winch control box on the bracket, find the right position. Try to press it as close to the winch as possible. If necessary, adjust the position of the winch control box on the mounting bracket (step 41).

**\*Tighten hardware from step 40-42.**

44. Secure factory wiring using cable ties (item U). Connect the winch.



Fig.45

45. If your vehicle has EGR fender flares, cut end cap covers (item 1) following marked line (fig. 45). Cover all trimming points using corrosion resistance coating.

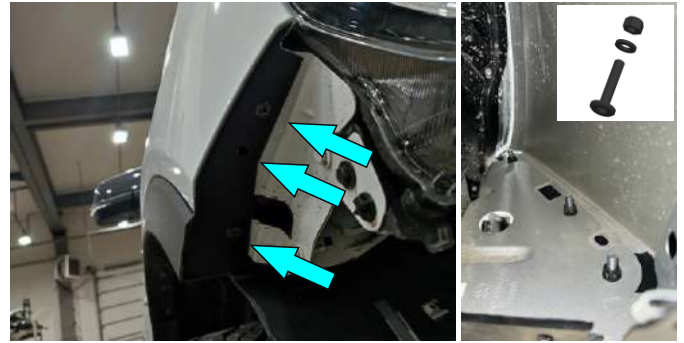

Fig.46

46. Secure the end cap covers using screws M6x20, washers M6, nuts M6 (items D, I1, E2).

**\*Tighten hardware after that.**

### Bumper body installation procedure



Fig.47

47. Mount weatherstrips (item 9) on end caps (items 8,10). Seal A should overlap seal B.

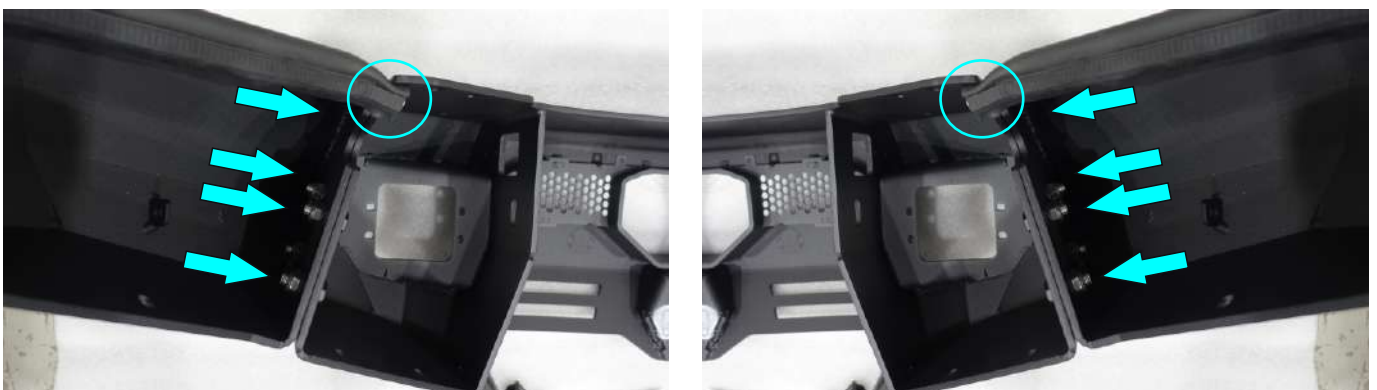

Fig.48

Fig.49

48. Fix end caps (items 8,10) to the bumper body (item 9) using insert bolts M10x30, washers M10, nuts M10 (items B2, H3, E4) (fig.48,49). Tuck in the sealant as shown in fig. 48,49.

**\*Tighten hardware after that.**

## Steps 49-50 in case you have EGR fender flares and Rival kit 2D.0083.1

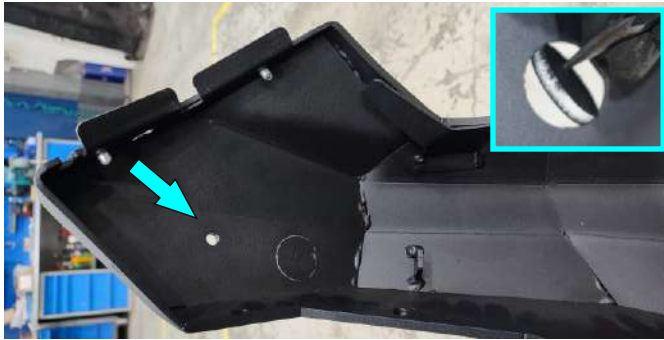

Fig.50

49. Hammer out 1 plug on each side (fig. 50).



Fig.51



Fig.52

50. Install cage nuts M6 (item G )(fig.51) and secure fender flares to bumper body using screws M6x20, washers M6, nuts M6 (item A2, I1, E2) (fig.52).

**\*Tighten hardware after that.**

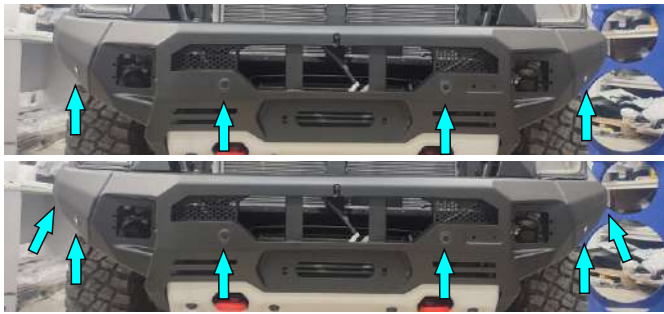

Fig.53

51. If your vehicle has 4 parking sensors, hammer out 4 plugs. If your vehicle has 6 parking sensors, hammer out 6 plugs.



Fig.54

52. Install parking sensor holders (item O), secure them using nuts (item Q). Use wrench (item 8) to tighten hardware.

### If your vehicle is not fitted with front camera, skip steps 53-57.



Fig.55

53. If your vehicle is fitted with front camera, install it to camera bracket (item 29) and secure it using camera clamp (item 28), screws M6x16, washers M6 (items A1, H1) (fig.55).

**\*Tighten hardware after that.**



Fig.56

54. Remove the clip from the wiring harness.



# INSTALLATION PROCEDURE



4x4 ACCESSORIES



Fig.57

55. Hammer out bumper plug.

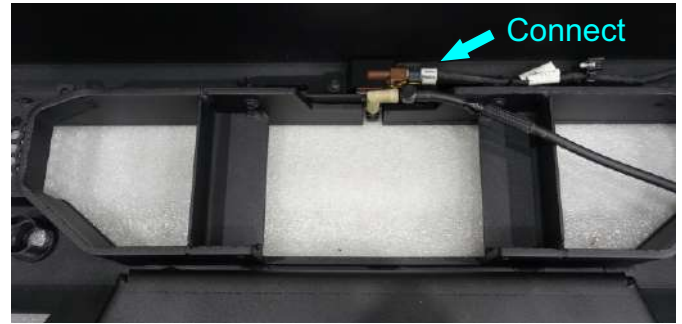

Fig.58

56. Connect the factory wiring plug.

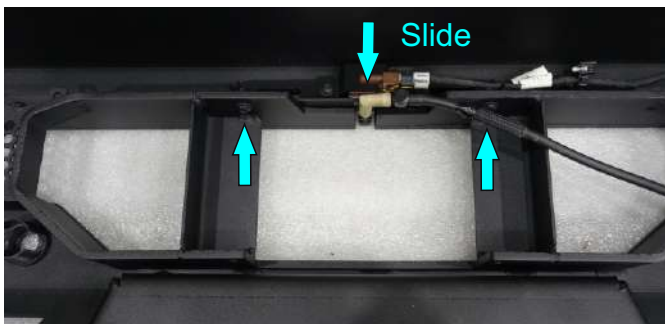

Fig.59

57. If your vehicle fitted with radar, secure camera using screws M6x20, washers M6 (A2, H1). Center camera and slide to bumper as far as possible.

**\*Tighten hardware ONLY if your vehicle is fitted with radar. Otherwise, skip tightening.**

**If your vehicle is not fitted with radar, secure radar cap, skip steps 58-62, 72-75.**

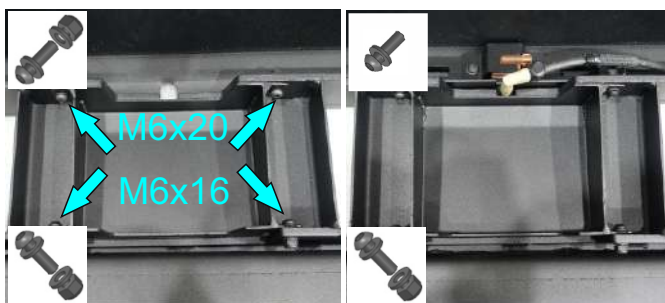

Fig.60

Fig.61

58. Secure radar cap (item 43) (fig.60) or radar cap and camera (fig.61) using screws M6x16, screws M6x20, washers M6, nuts M6 and camera bracket (items 29, A1, A2, H1, E2). Center camera and slide to bumper as far as possible.

**\*Tighten hardware after that.**

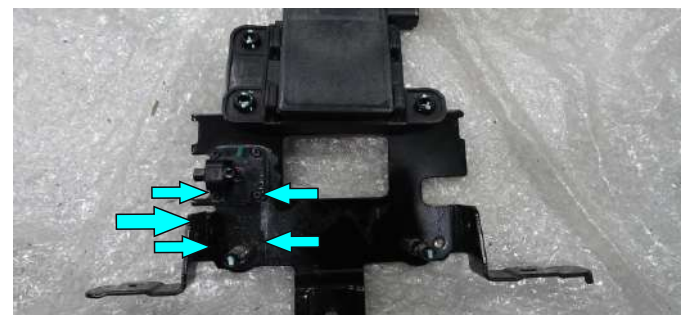

Fig.62

59. Remove radar from factory bracket, and after that the adjusting mechanism (fig.62).

**\*Set aside for re-use later on.**

# INSTALLATION PROCEDURE

# RIVAL

4x4 ACCESSORIES

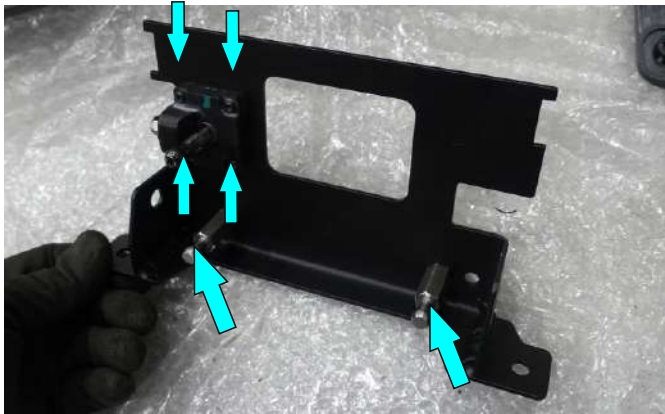

Fig.63

60. Install radar mounting pins (item R) using nuts M6, washers M6 (items E2, H1). Fix adjusting mechanism using nuts M3 (item E1).  
**\*Tighten hardware after that.**



Fig.64

61. Secure radar on radar bracket.

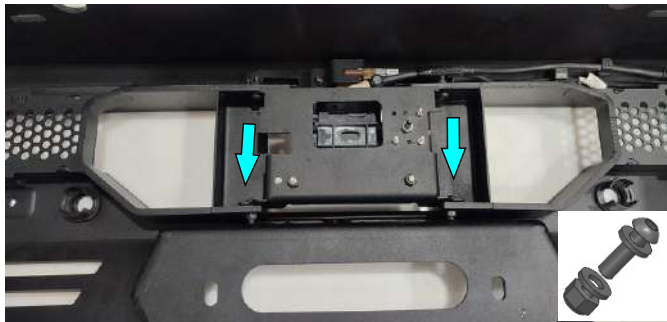

Fig.65

62. Secure radar bracket to bumper body using screws M6x16, washers M6, nuts M6 (items A1, H1, E2).  
**\*Tighten hardware after that.**



Fig.66

63. Secure license plate bracket (item 37) to bumper body using screws M6x16, washers M6, license plate insert nut (items A1, I1, 41).  
**\*Do not tighten yet.**



Fig.67

64. Measure thickness of fairlead and shackle that you are planning to install. Slide license plate bracket according to measured size.  
**\*Be aware that thickness should be less than 60 mm.**  
**\*Tighten hardware after that.**



Fig.68

65. Secure adjustment brackets (items 26, 31) to bumper body using screw M10x30, countersunk washers (items C, N).  
**\*Do not tighten yet.**

# INSTALLATION PROCEDURE

# RIVAL

4x4 ACCESSORIES



Fig.69

66. Relocate wiring from factory bumper to Rival bumper.



Fig.70

67. Install parking sensors in the holders, secure them using clamps (item P) (fig.70).



Fig.71

68. Secure the wiring using cable ties (item U).



Fig.72



Fig.73

69. Place the bumper body on winch bracket. Connect the camera wiring plug and camera washing pipe.

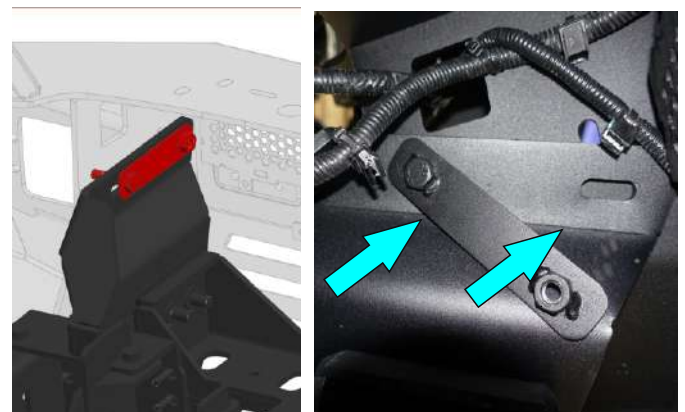

Fig.74

70. Install insert nuts M10x1.5 (item K) through central holes of the bumper. Secure it using screws M10, countersunk washers M10, washers M10, nuts M10 (items C, N, I3, E4).  
**\*Do not tighten yet.**

# INSTALLATION PROCEDURE

# RIVAL

4x4 ACCESSORIES

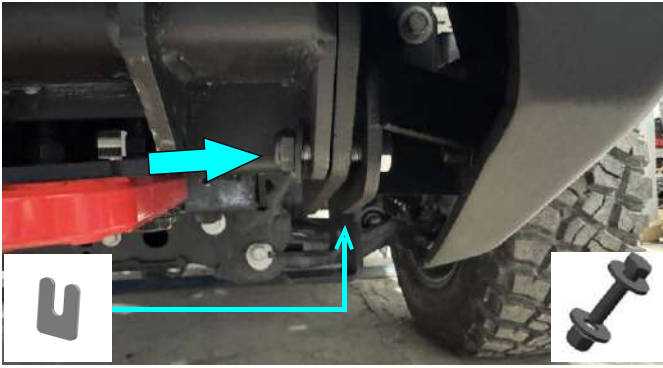

Fig.75

71. Secure brackets from step 62 to winch bracket using bolts M10x40, washers M10, nuts M10 and adjusting plate 2mm (items B3, I3, E4).

**\*Do not tighten yet.**



Fig.76

72. Align bumper body on the vehicle, tuck in the sealant to each bumper end caps and tighten hardware from step 70, 71.



Fig.77

73. The bumper body and the wing of the vehicle should be parallel each other.

**\*Make sure that the gap is not less than 25 mm (1 in) to avoid headlight damage.**



Fig.78

74. The gap between the headlight and the sealant but it should be not less than 1 mm (0.04 in).

**\*Adjust the body bumper to keep the gap to a minimum**



Fig.79

75. Align the radar position perpendicular to the road using side bolt on adjusting mechanism.

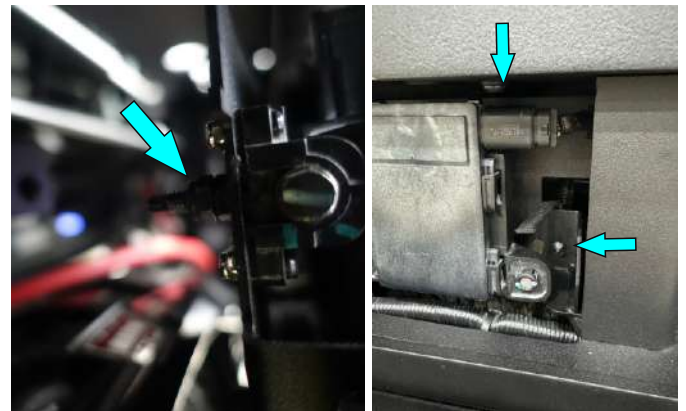

Fig.80

76. Install nut M6 (item E2) on adjusting mechanism. Connect the radar plug and secure the wiring.



Fig.81

77. Install factory radar cover, secure it using factory clips.

## Step 78-82 in case you have lightbar

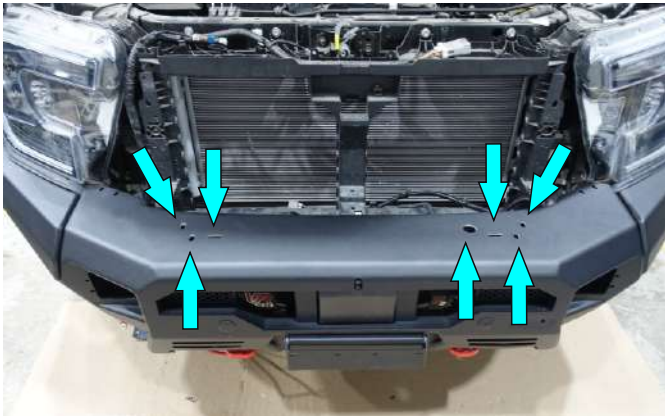

Fig.82

78. Hammer out plugs from the upper face of bumper body (fig. 82).



Fig.83

79. Install lightbar brackets (items 3, 4) to lightbar using lightbar hardware.  
**\*Do not tighten yet.**



Fig.84

80. Install lightbar on the bumper body and secure the brackets (items 3,4) using bolts M8x30, washers M8, nuts M8 (items B1, I2, E3). Adjust the lightbar.

**\*Tighten hardware after that.**

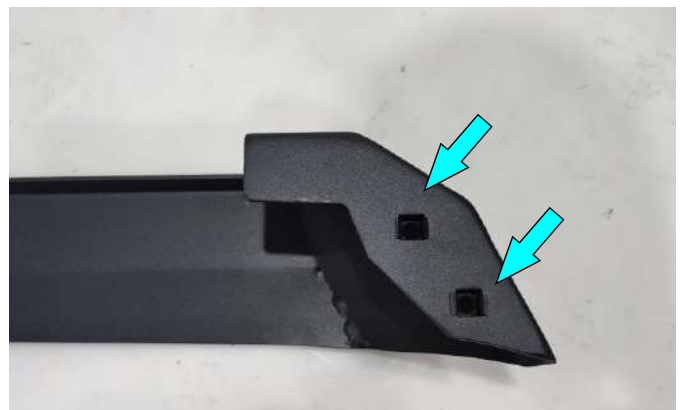

Fig.85

81. Install cage nuts M8 (item F) on lightbar cap (item 6) as shown on fig.85.

# INSTALLATION PROCEDURE



4x4 ACCESSORIES



Fig.86

82. Secure lightbar cap (item 6) to the bumper body using bolts M8x30, washers M8 (item B1, I2). Adjust lightbar cap.

**\*Tighten hardware after that.**



Fig.87

83. Install a fairlead to the bumper using fairlead hardware and insert nuts M10 (item L).

**\*Tighten hardware from step 39.**



Fig.88

84. Install factory or any aftermarket radiator skid plate (fig. 88).

**\*Tighten hardware after that.**



Fig.89

85. Secure bash plate brackets 1 (items 14,17) on both sides using bolts M8x30, washers 8 and nuts M8 (item B1, H2, E3).

**\*Tighten hardware after that.**



Fig.90

86. Install insert nuts M10 with wires (item J).

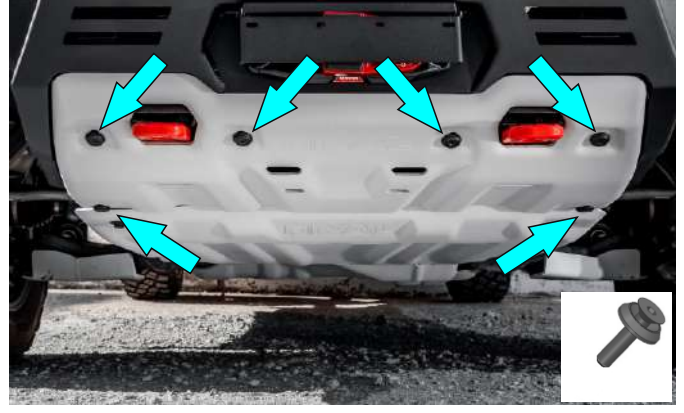

Fig.91

87. Install bash plate (item 24) and secure it using screws M10x30, washers M10 (item C, N). Align the bash plate.

**\*Tighten hardware after that.**



Fig.92



Fig.93

88. Install left and right plugs between wing and light brackets (items 2,5) using screws M6, washers 6 and insert nuts 2M6x1 (items A2, H1, M) (fig.92. 93). It's more convenient to use the hole for the lights to install brackets.

**\*Do not tighten yet.**



Fig.94



Fig.95

89. Secure grille brackets (item 25, 32) using:  
a). factory bolts  
b). screws M6x20, washers M6, nuts M6 (item A2, H1, E2) (fig.94).

**\*Tighten hardware after that.**

90. Install grille (fig.95).



Fig.96



Fig.97

91. Adjust the position of the headlight brackets to ensure an even gap between the bracket, the headlight and the grille (fig.96).  
**\*Make sure that the gap is 3 mm (0,11 in) or more to avoid headlight damage.**

92. Tighten the hardware from step 88.

# INSTALLATION PROCEDURE



4x4 ACCESSORIES



Fig.98

93. **Rival LED lights:** install them using supplied hardware.

**Others or light caps (item 42):** install them using screws M6x20, washers M6 and LED light brackets (items 35, A2, H1).

**\*Tighten hardware after that.**

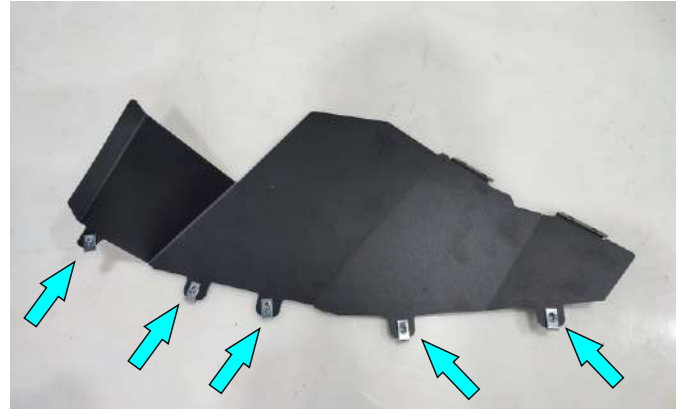

Fig.99

94. Install cage nuts M6 (item G) on flaps (items 13, 19) (fig.99).



Fig.100

95. Install flaps and secure them using screws M6x20, washers M6 (items A2, H1) (fig.100).

**\*Tighten hardware after that.**

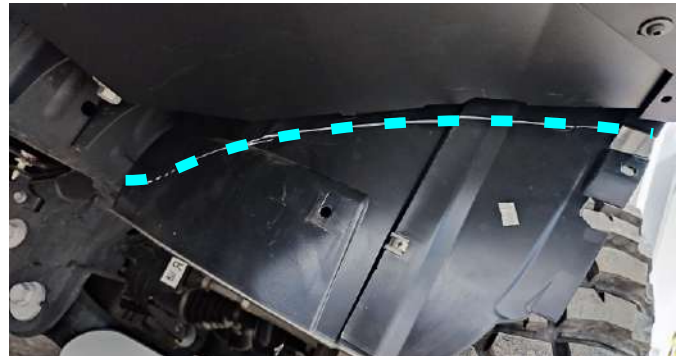

Fig.101

96. Mark a cutting line. Cut plastic inner fender using jig-saw or shears (fig.101). For convenience, the fender can be removed during trimming.

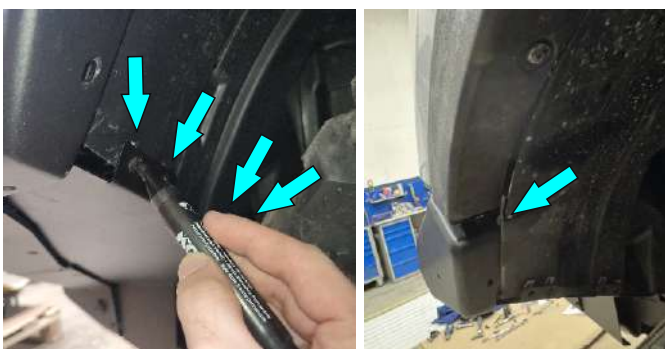

Fig.102

Fig.103

97. Match holes in plastic inner fender with holes in flap. Next, mark the matched holes and extra parts of inner fender on each side of the vehicle (fig.102). For convenience, it is recommended to remove the wheel or turn the wheel to its maximum extent.

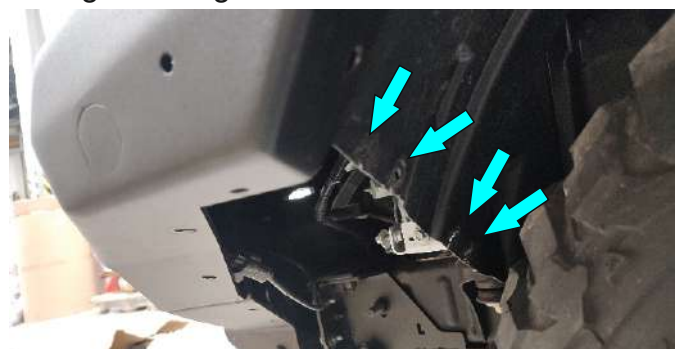

Fig.104

98. Remove the flap. Drill holes in plastic fender (fig.104) and cut extra parts of the inner fender on each side of the vehicle (fig.103).

# INSTALLATION PROCEDURE



4x4 ACCESSORIES

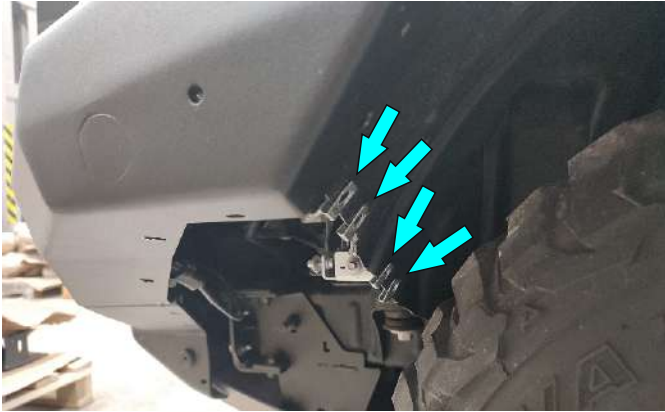

Fig.105

99. Pre-install cage nuts (item G) on plastic fenders.

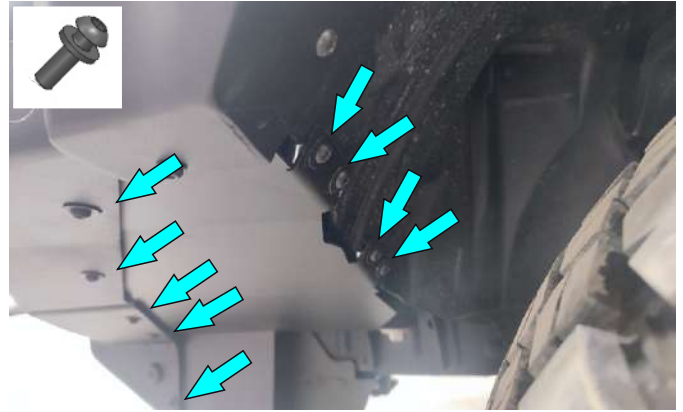

Fig.106

100. Slide and secure flap using screws M6x20, washers M6 (items A2, H1) on both sides of the vehicle (fig. 106).

**\*Tighten hardware from steps 84, 85.**



Fig.107

101. Connect factory wiring (fig.107).



Fig.108

102. Install factory bolts (fig.108).

**\*Tighten hardware after that.**

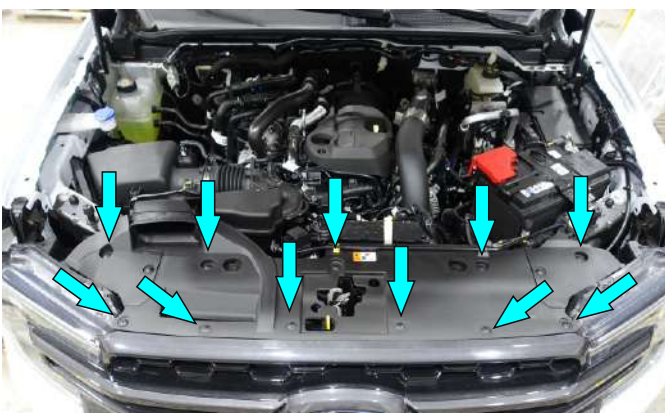

Fig.109

103. Install factory plastic pad clip and secure it using factory clips (fig.109).



Fig.110

104. Connect terminal "-" on the vehicle battery (fig.110).

Before operating a vehicle fitted with RIVAL front bumper:

- make sure all fittings are tightened;
- ensure the integrity of the structure and its components.

